

KM/55001/M, Roundline cylinders stainless steel, magnetic piston, double acting

- \varnothing 32 ... 125 mm
- Clean line design
- High corrosion and acid resistance
- Magnetic piston as standard
- Suitable for applications in the food industry
- Special wiper/ seal as standard



Technical features

Medium:

Compressed air, filtered, lubricated or non-lubricated

Operation:

Double acting, magnetic piston, adjustable cushioning

Operating pressure:

1 ... 10 bar (14 ... 145 psi)

Cylinder diameters:

32 ... 125 mm

Non-standard strokes:

Non-standard strokes (1600 mm max. available)

Operating temperature:

-20°C ... +80°C (-4 ... +176°F)
Maximum 150°C (+302°F) heat resistant seals

Air supply must be dry enough to avoid ice formation at temperatures below +2°C (+35°F).

Materials:

Barrel: X5 Cr Ni 18 10 (1.4301; AISI 304)
End covers: X10 Cr Ni S 18 9 (1.4305; AISI 303)
Piston rod: X10 Cr Ni S 18 9 (1.4305; AISI 303)
O-rings: FPM
Piston seal: PUR
Cushion seal: NBR

Technical data

Cylinder \varnothing (mm)	32	40	50	63	80	100	125
Port size	G 1/8	G 1/4	G 1/4	G 3/8	G 3/8	G 1/2	G 1/2
Piston rod \varnothing (mm)	12	16	20	20	25	25	32
Piston rod thread (mm)	M10 x 1,25	M12 x 1,25	M16 x 1,5	M16 x 1,5	M20 x 1,5	M20 x 1,5	M27 x 2
Cushion length (mm)	19	22	24	24	27	34	41
Theoretical thrusts at 6 bar outstroke (N)	482	754	1178	1870	3016	4710	7363
Theoretical thrusts at 6 bar instroke (N)	414	633	990	1680	2722	4416	6882
Air consumption at 6 bar outstroke (l/cm)	0,056	0,088	0,137	0,218	0,35	0,55	0,86
Air consumption at 6 bar instroke (l/cm)	0,048	0,074	0,114	0,195	0,32	0,51	0,79

Design and sizing in pneumatics

Golden Rules

Design and sizing in pneumatics is often based upon experience coupled with an element of fear of under specifying crucial equipment. In an attempt to ensure enough power, engineers may select over sized cylinders and then select over sized valves to supply them with enough air. The same uncertainty can also lead to over sized specification of air line equipment, fittings and tubing. The outcome is components larger than necessary that use too much compressed air and waste energy and money. However when following some well proven golden rules and a few laws of pneumatics it is easy to achieve correctly sized pneumatic installations.

Golden Rule:

The theoretical force of the cylinder should be 25% extra for high speed, 50% extra for low speed and 100% extra for ultra low speed (positioning) applications.

The correct sizing is based upon the required force and applied pressure. Go to page 1 for more information on cylinder sizing and air consumption.

Basics to Consider

The force required, the pressure available, the speed of movement and air consumption. ISO and VDMA standard or compact style also cushioning and sensors. Cylinders are greased on assembly and operate under normal conditions without additional lubrication. However using a lubricator will extend the life of these products.

Load and Buckling

For applications with high side loading, use pneumatic slide actuators or standard cylinders fitted with guide units. Alternatively external guide bearings should be installed. When a long stroke length is specified, care must be taken to ensure the rod length is within the limits for prevention of buckling. The table shows the maximum stroke length for a variety of installation arrangements.

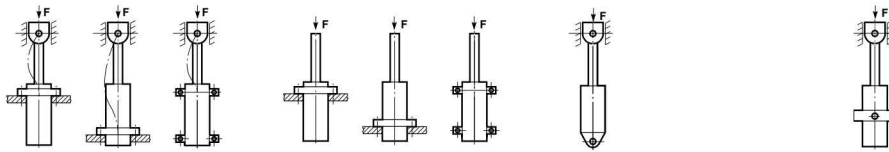

Cylinder ø (mm)	Piston rod ø (mm)	Load case 1 Pressure (bar)				Load case 2 Pressure (bar)				Load case 3 Pressure (bar)				Load case 4 Pressure (bar)			
		4	6	10	16	4	6	10	16	4	6	10	16	4	6	10	16
32	12	1100	860	650	500	500	390	290	210	650	520	380	290	760	600	450	340
40	16	1600	1200	950	730	730	580	430	320	940	750	560	430	1100	880	660	500
50	20	2000	1600	1200	930	930	740	550	420	1200	960	720	550	1400	1100	840	640
63	20	1500	1200	930	720	720	570	420	310	930	740	550	420	1100	860	650	490
80	25	1900	1500	1100	880	880	700	510	380	1100	910	680	510	1300	1100	800	600
100	25	1500	1200	880	670	670	520	380	270	880	690	510	370	1000	820	600	450
125	32	2000	1600	1200	910	910	710	520	380	1200	940	690	520	1400	1100	820	620
160	40	2400	1900	1500	1100	1100	880	640	480	1400	1200	860	640	1700	1400	1000	760
200	40	1900	1500	1100	860	860	670	480	350	1100	890	650	480	1300	1000	770	580
250	50	2400	1900	1400	1100	1100	850	620	440	1400	1100	830	610	1700	1300	980	730
320	63	3000	2400	1800	1400	1400	1100	780	570	1800	1400	1000	780	2100	1700	1200	930

Cylinder variants

Symbol	Model magnetic piston	Description	Dimensions Page
	KM/55000/M	Standard cylinders with female threads on rear end cover for trunning mounting	4
	KM/55000/MF	Cylinders with threaded front end cover	4
	KM/55000/MFT	Standard cylinders with female threads on front end cover for trunning mounting	4
	KM/55000/M/D2	Cylinders with integral clevis mounting	5
	KM/55000/M/R	Cylinders with integral rear eye mounting	5
	KM/55000/M/UR	Cylinders with integral universal rear eye mounting	5
	TKM/55000/M	High temperature cylinders, 150°C max.	4
	KM/55000/MU	Standard cylinders with extended piston rod and female threads on rear end cover for trunning mounting	4
	KM/55000/JM	Cylinders with double ended piston rod and threaded front end covers (Ø 32 to 63 mm)	4

For the cylinder of alternative options consult our technical service

Option selector

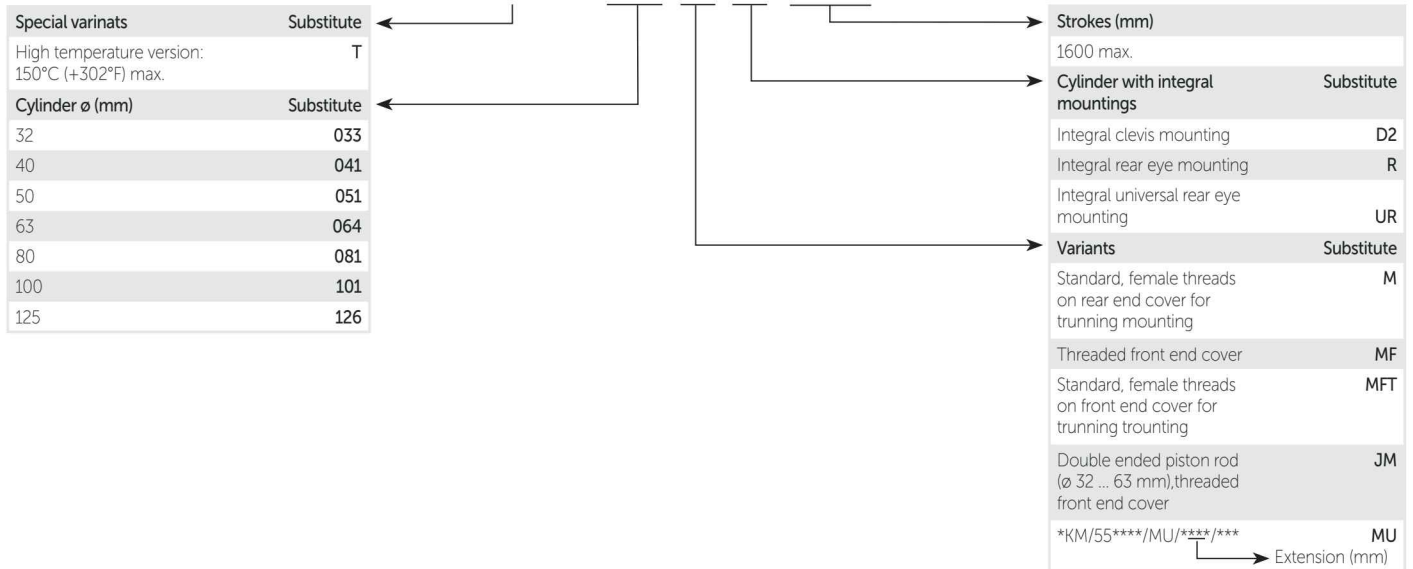

Materials of mountings and accessories Standard cylinders

Cylinder variant

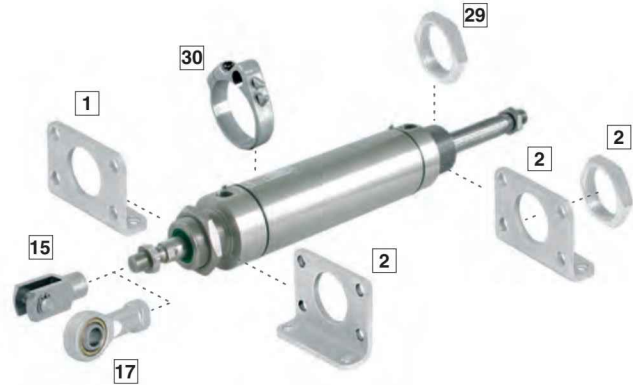

Position	Style	Stainless steel	Position	Style	Stainless steel
1	B/G	Flange mounting: X 5 Cr Ni 18 10 (1.4301; AISI 304)	15	F	Piston rod clevis mounting: X 10 Cr Ni S 18 9 (1.4305; AISI 303)
2	C	Foot mounting: X 5 Cr Ni 18 10 (1.4301; AISI 304)	17	UF	Body: X 5 Cr Ni 18 10 (1.4301; AISI 304), Inner ring: X 105 Cr Co 18-2 (1.4528), Outer ring: X 10 Cr Ni S 18 9 (1.4305; AISI 303)
6	L	Rear hinge mounting: X 5 Cr Ni 18 10 (1.4301; AISI 304), bolt: X 10 Cr Ni S 18 9 (1.4305; AISI 303), eyebolt: X 10 Cr Ni S 18 9 (1.4305; AISI 303)	29	Nose nut	X 10 Cr Ni S 18 9 (1.4305; AISI 303)
11	H	Central trunnion: X 10 Cr Ni S 18 9 (1.4305; AISI 303)	30	Bracket for switches	Body \varnothing 32 ... 80 mm POM, \varnothing 100 & 125 mm stainless steel Screws stainless steel

Cyl.	B, G	C	F	H	L	N	UF
\varnothing (mm)	1 Page 6	2 Page 6	8 Page 6	13 Page 6	12 Page 7	3 Page 6	6 Page 6
32	M/P34297	KQM/55433/21	KQM/55433/25	QM/55232/28	KQM/55032/24	M/P34276	KQM/8025/32
40	M/P34298	KQM/55441/21	KQM/55441/25	QM/55240/28	KQM/55040/24	M/P34277	KQM/8040/32
50	M/P34299	KQM/55451/21	KQM/55451/25	QM/55250/28	KQM/55050/24	M/P34278	KQM/8050/32
63	M/P34300	KQM/55464/21	KQM/55451/25	QM/55263/28	KQM/55063/24	M/P34278	KQM/8050/32
80	-	-	KQA/8080/25	QM/55480/28	KQM/55080/24	-	KQM/8080/32
100	-	-	KQA/8080/25	QM/55410/28	KQM/55100/24	-	KQM/8080/32
125	-	-	KQA/8125/25	QM/55125/28	KQM/55125/24	-	KQM/8125/32

Cyl.	Switch mounting	Magnetically operated switches	Service kit
\varnothing (mm)	9 Page 7	Page 8 & 9	
32	QM/33/432/22		KQM/55032/00
40	QM/33/440/22		KQM/55040/00
50	QM/33/450/22		KQM/55050/00
63	QM/33/463/22		KQM/55063/00
80	QM/33/080/22		KQM/55080/00
100	QM/33/100/22		KQM/55100/00
125	QM/33/125/22		KQM/55125/00

Dimensions

Standard cylinders

KM/55001/M – Standard cylinders with female threads on rear end cover for trunning mounting

Cylinder variant

KM/55001/MFT – Standard cylinders with female threads on front end cover for trunning mounting

Dimensions in mm
Projection/First angle

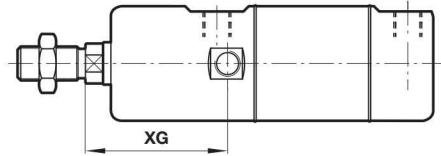
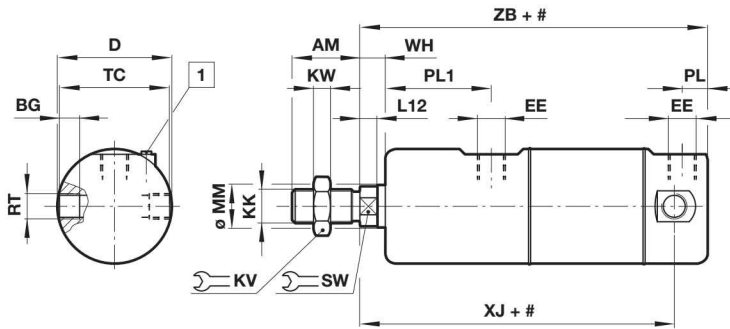
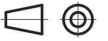

Stroke
1 Cushion screw

ø	AM	BG	ø D	EE	KK	KV	KW	L12	ø MM	PL	PL1	RT	SW	TC	WH	XL	XG	ZB	kg at 0 mm	kg per 25 mm	Model
32	22	6	36	G 1/8	M10 x 1,25	17	5	6	12	9	39	M8 x 1	10	34,5	8	124,5	47	132	0,78	0,06	KM/55033/M/*
40	24	8	44	G 1/4	M12 x 1,25	19	6	6,5	16	15	50	M10 x 1	13	42	10	142	57	154	1,36	0,09	KM/55041/M/*
50	32	9,5	54	G 1/4	M16 x 1,5	24	8	8	20	12	50	M12 x 1,5	17	52	12	152	62	164	2,25	0,13	KM/55051/M/*
63	32	10	68	G 3/8	M16 x 1,5	24	8	8	20	13	51	M14 x 1,5	17	66	13	159	64	172	3,78	0,16	KM/55064/M/*
80	40	18	86	G 3/8	M20 x 1,5	30	10	10	25	16	47	M16 x 1,5	22	83,5	13	160	60	176	5,99	0,25	KM/55081/M/*
100	40	22	106	G 1/2	M20 x 1,5	30	10	10	25	19	47	M20 x 1,5	22	102,5	15	178	62	197	10,36	0,29	KM/55101/M/*
125	54	29	133	G 1/2	M27 x 2	41	13,5	13	32	17,5	62,5	M24 x 1,5	27	128,5	20	207,5	82,5	225	22,97	0,48	KM/55126/M/*

* Please insert stroke length.

Cylinder variants

KM/55001/JM – Cylinders with double ended piston rod and threaded front end covers

KM/55001/MF – Cylinders with threaded front end cover

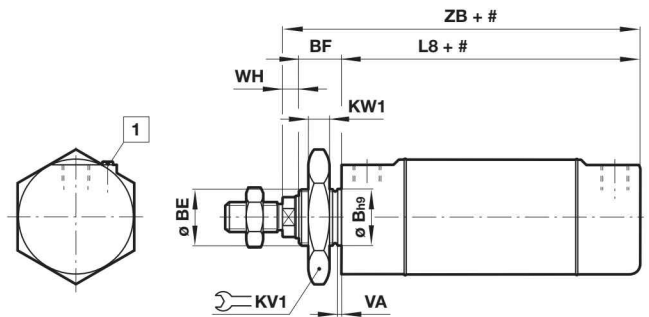
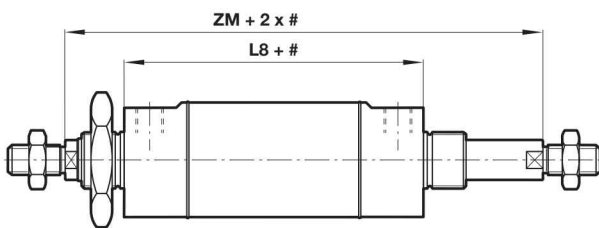

ø	L8	ZM	Model
32	94	170	KM/55033/JM/*
40	109	199	KM/55041/JM/*
50	114	214	KM/55051/JM/*
63	121	223	KM/55064/JM/*

* Please insert stroke length.

ø	ø Bh9	BE	BF	KV1	KW1	L8	VA	WH	ZB	Model
32	30	M30x1,5	30	36	8	94	3	8	132	KM/55033/MF/*
40	38	M38x1,5	35	46	10	109	3	10	154	KM/55041/MF/*
50	45	M45x1,5	38	55	10	114	3	12	164	KM/55051/MF/*
63	45	M45x1,5	38	55	10	121	3	13	172	KM/55064/MF/*

* Please insert stroke length.

Cylinder variant
KM/55001/M/D2 – cylinder with integral clevis mounting

Dimensions in mm
 Projection/First angle

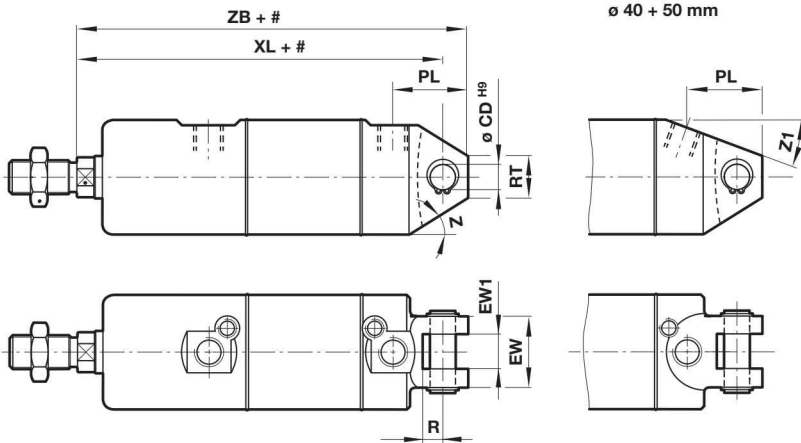

stroke

Ø	Ø CDH9	EW	EW1+0,2	PL	R	RT	XL	Z	Z1	ZB	kg at 0 mm	kg per 25 mm	Model
32	10	26	14	30,5	16,5	19	142	20°	–	151	0,78	0,06	KM/55033/M/D2/*
40	12	32	16	36,5	19,5	18	160	25°	15°	172	1,35	0,09	KM/55041/M/D2/*
50	12	41	21	36,5	21,5	24	170	30°	20°	182	2,24	0,13	KM/55051/M/D2/*
63	16	41	21	46	23,5	25,5	190	30°	–	205	3,74	0,16	KM/55064/M/D2/*

* Please insert stroke length.

KM/55001/M/R – cylinder with integral rear eye mounting

Ø	Ø CDH9	EW	PL	R	RT	XL	Z	ZB	kg at 0 mm	kg per 25 mm	Model
32	10	25,8	29	14,5	19	142	20°	151	0,94	0,06	KM/55033/M/R/*
40	12	27,8	34	16	18	160	25°	172	1,47	0,09	KM/55041/M/R/*
50	12	31,7	33,5	19	24	170	30°	182	2,32	0,13	KM/55051/M/R/*
63	16	39,7	46	22	25,5	190	30°	205	3,98	0,16	KM/55064/M/R/*
80	16	49,7	65	24	41	210	30°	225	7,40	0,25	KM/55081/M/R/*
100	20	59,7	71	27	51	230	30°	250	12,54	0,29	KM/55101/M/R/*

* Please insert stroke length.

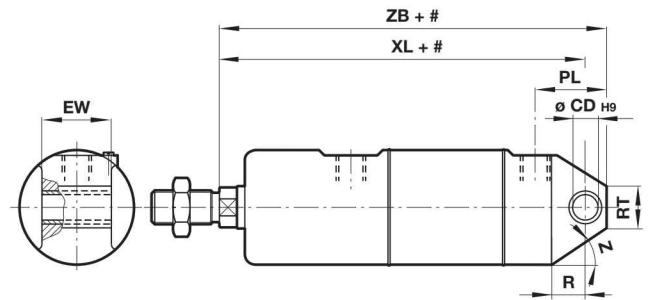

KM/55001/M/UR – cylinder with integral universal rear eye mounting

Ø	Ø CNH7	EN-0,1	PL	R	RT	XL	Z	ZB	kg at 0 mm	kg per 25 mm	Model
32	10	14	36	14,5	17,5	142	13°	158	0,84 kg	0,06	KM/55033/M/UR/*
40	12	16	41	16	28,5	160	13°	178	1,41 kg	0,09	KM/55041/M/UR/*
50	16	21	42,5	19	34	170	13°	191	2,31 kg	0,13	KM/55051/M/UR/*
63	16	21	55	22	35,5	190	15°	213	3,82 kg	0,16	KM/55064/M/UR/*
80	20	25	78	24	37,5	210	15°	238	7,32 kg	0,25	KM/55081/M/UR/*
100	20	25	81	27	40,5	230	15°	260	12,26 kg	0,29	KM/55101/M/UR/*

* Please insert stroke length.

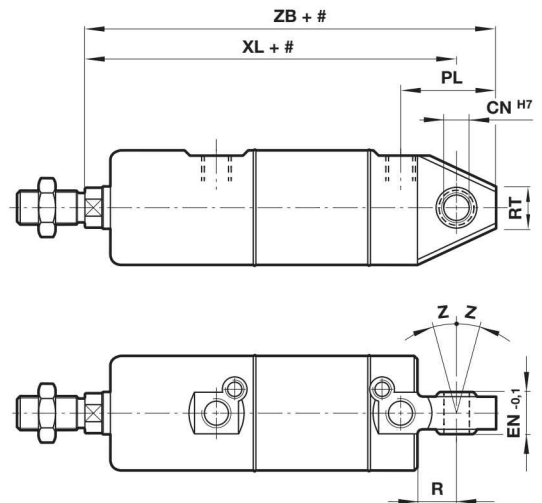

Mountings

Rear flange B, front flange G

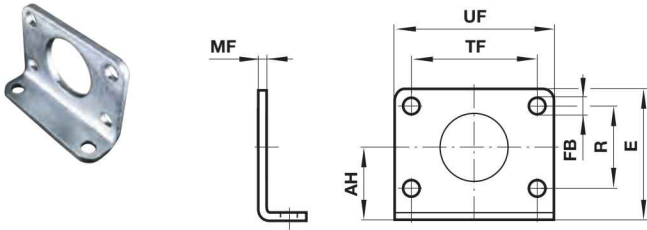

ø	AH	E	ø FB	MF	R	TF	UF	kg	Model
32	28	49	7	4	28	52	66	0,11	M/P34297
40	33	58	9	5	30	60	80	0,19	M/P34298
50	40	70	9	5	40	70	90	0,25	M/P34299
63	45	80	9	5	50	76	96	0,33	M/P34300

Foot C

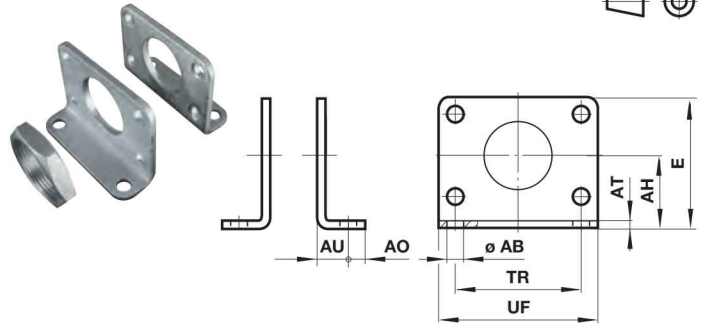

ø	ø AB	AH	AO	AT	AU	E	TR	UF	kg	Model
32	7	28	7	4	14	49	52	66	0,25	KQM/55433/21
40	9	33	10	5	20	58	60	80	0,44	KQM/55441/21
50	9	40	10	5	20	70	70	90	0,59	KQM/55451/21
63	9	45	10	5	20	80	76	96	0,73	KQM/55464/21

Piston rod clevis F

Conforms to DIN ISO 8140

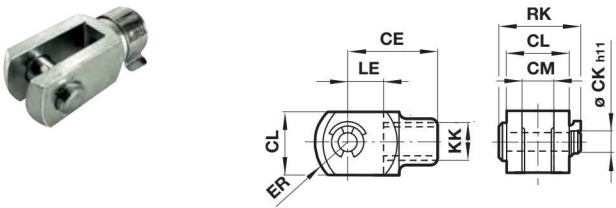

ø	KK	CE	ø CKh11	CL	CM	ER	LE	RK	kg	Model
32	M10x1,25	40	10	20	10	16	20	28	0,09	KQM/55433/25
40	M12x1,25	48	12	24	12	19	24	32	0,13	KQM/55441/25
50/63	M16x1,5	64	16	32	16	25	32	41,5	0,33	KQM/55451/25
80/100	M20x1,5	80	20	40	20	32	40	50	0,67	KQA/8080/25
125	M27 x 2	110	30	55	30	45	54	72	1,35	KQA/8125/25

End cover trunnion H

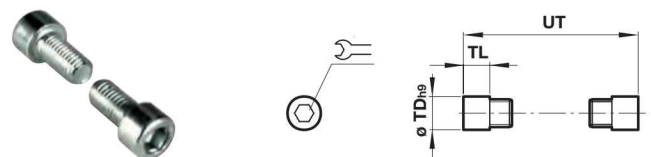

ø	ø TDh9	TL	UT	⌘	kg	Model
32	10	8	51	5	0,02	QM/55232/28
40	12	9,5	63	6	0,03	QM/55240/28
50	14	11	76	6	0,05	QM/55250/28
63	16	13	93	8	0,07	QM/55263/28
80	18	13	111,5	8	0,09	QM/55480/28
100	20	14	131,5	10	0,25	QM/55410/28
125	25	20	168,5	10	0,32	QM/55125/28

Nose nut N

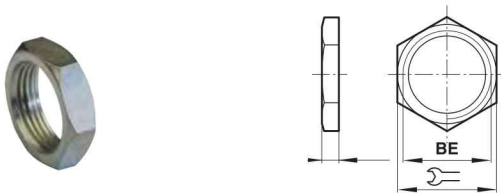

ø	BE	⌘	KW	kg	Model
32	M30 x 1,5	36	8	0,03	M/P34276
40	M38 x 1,5	46	10	0,06	M/P34277
50/63	M45 x 1,5	55	10	0,08	M/P34278

Universal piston rod eye UF

Conforms to DIN ISO 8139

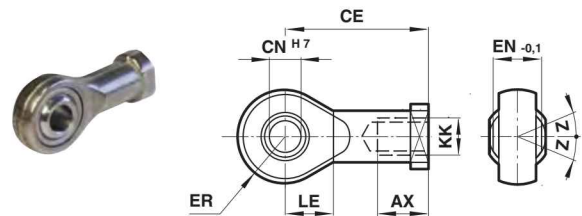

ø	Thread KK	AX	CE	ø CNH7	EN-0,1	ER	LE	Z	kg	Model
32	M10x1,25	20	43	10	14	14,5	15	13°	0,09	KQM/8032/32
40	M12x1,25	22	50	12	16	16,5	17	13°	0,13	KQM/8040/32
50/63	M16x1,5	28	64	16	21	21,5	22	15°	0,33	KQM/8050/32
80/100	M20x1,5	33	77	20	25	25,5	26	15°	0,67	KQM/8080/32
125	M27x2	51	110	30	37	35	35	15°	1,15	KQM/8125/32

Rear hinge L

Dimensions in mm
Projection/First angle

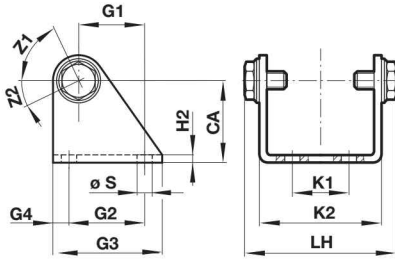

ø	CA	G1	G2	G3	G4	ø S	H2	K1	K2	LH	Z1	Z2	kg	Model
32	35	20	24	40	8	7	4	20	46,5	59,5	202°	36°	0,15	KQM/55032/24
40	40	27	30	50	10	9	5	28	56,5	71	197°	33°	0,26	KQM/55040/24
50	45	30	34	54	10	9	5	36	68,5	83	196°	31°	0,33	KQM/55050/24
63	50	34	35	65	15	9	5	42	82,5	99	191°	25°	0,51	KQM/55063/24
80	65	47,5	55	80	12,5	11	6	55	102,5	125,5	193°	27°	0,96	KQM/55080/24
100	77	63	70	100	15	11	6	70	122,5	145,5	192°	27°	1,37	KQM/55100/24
125	90	82,5	90	125	17,5	13,5	8	90	152,5	175,5	188°	22°	2,51	KQM/55125/24

Switch mounting bracket

QM/33/xxx/22

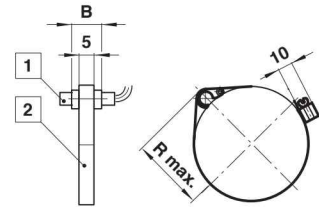

- 1 Magnetically operated switch
- 2 Switch mounting bracket

ø	B	R max.	Model
32	10	29	QM/33/432/22
40	10	32	QM/33/440/22
50	10	38	QM/33/450/22
63	10	46	QM/33/463/22

ø	B	R max.	Model
80	12	54	QM/33/080/22
100	10	59	QM/33/100/22
125	10	72,5	QM/33/125/22

- Magnetically operating reed switch - Round style
- Suitable for all cylinder ranges with magnetic piston
- Switches can be mounted flush with the delivered special adaptor
- LED indicator on LSU models
- Alternative variants allows a wide range of application



Technical features

Operation: M/50/LSU Normally open with LED (yellow)	Switching power: 10 W/10 VA max.	Protection rating (EN 60529): IP66	Cable length: 2, 5 or 10 m
Switching voltage (U_b): 10 ... 240 V a.c./170 V d.c.	Contact resistance: 150 mΩ	Shock resistance: 50 g (during 11 ms)	Electromagnetic compatibility according to: EN 60947-5-2
Switching voltage output: U _b - 2,7 V	Response time: 1,8 ms	Vibration resistance: 35 g (at 2000 Hz)	Materials: Body: plastic Cable: see table below
Switching current (see graph overleaf): 0,18 A max.	Operating temperature: -25 ... +80°C (-13 ... +176°F)	Cable type: 2 x 0,25: PVC, PUR or silikon 3 x 0,25 PVC	
	High temperature version: +150°C max.(+302 °F)		

Technical data - Reed switches - additional information see data sheet en 4.3.005

Symbol	Voltage (V a.c.)	Voltage (V d.c.)	Current maximum (mA)	Function	Operating temperature (°C)	LED	Protection class	Plug	Cable length (m)	Cable type	Weight (g)	Model
	10 ... 240	10 ... 170	180	Normally open	-25 ... +80	•	IP 66	—	2, 5 or 10	PVC 2 x 0,25	37	M/50/LSU/*V
	10 ... 240	10 ... 170	180	Normally open	-25 ... +80	•	IP 66	—	5	PUR 2 x 0,25	37	M/50/LSU/5U
	10 ... 240	10 ... 170	180	Normally open	-25 ... +150	—	IP 66	—	2	Silicon 2 x 0,25	37	TM/50/RAU/2S
	10 ... 240	10 ... 170	180	Changeover	-25 ... +80	—	IP 66	—	5	PVC 3 x 0,25	37	M/50/RAC/5V
	10 ... 60	10 ... 60	180	Normally open	-25 ... +80	•	IP 66	M8 x 1	0,3	PVC 3 x 0,25	16	M/50/LSU/CP *1)
	10 ... 60	10 ... 60	180	Normally open	-25 ... +80	•	IP 66	M12 x 1	0,3	PVC 3 x 0,25	16	M/50/LSU/CC *1)

* Insert cable length; *1) Plug-in connector see page 10

Dimensions

M/50/LSU/*V, M/50/LSU/5U,
TM/50/RAU/2S
Cable length L = 2, 5 or 10 m



M/50/RAC/5V
Cable length L = 5 m



M/50/LSU/CP
M/50/LSU/CC



Dimensions in mm
Projection/First angle

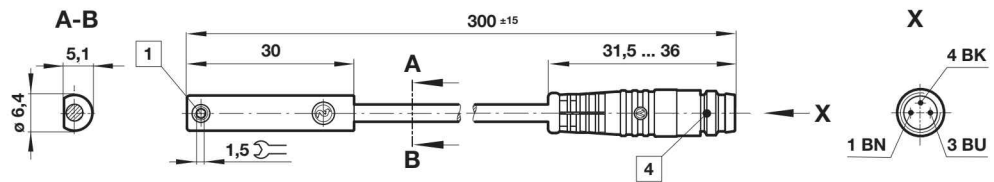
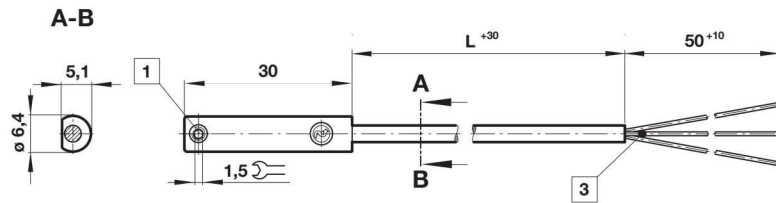
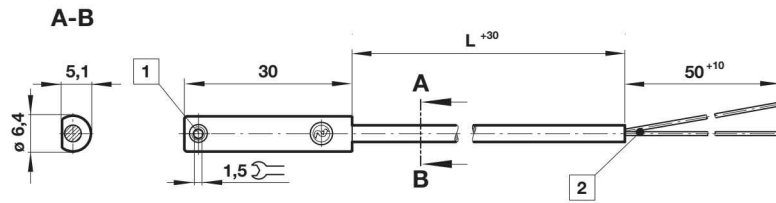

- 1 Fixing screw
- 2 + BN = brown; - BU = blue (output)
- 3 - BK = black; + BN = brown; - BU = blue
- 4 Version CP: Plug M8 x 1, color code: BK = +; BN = -; BU = output
Version CC: Plug M12 x 1, color code: BK = +; BN = -; BU = output

Accessories

Plug-in connector cable with nut



Outer cover	Cable length (m)	Weight (kg)	Connector	Connector
PVC 3 x 0,25	5	0,18	M8 x 1	M/P73001/5
PUR 3 x 0,25	5	0,18	M8 x 1	M/P73002/5
PUR 3 x 0,34	5	0,21	M12 x 1	M/P34594/5

- Magnetically operated solid state switch - round style
- IO-Link version available
- Suitable for all cylinder ranges with magnetic piston
- Switches can be mounted flush in all profile cylinders
- Reliable switching with a very fast reponse time
- Particularly suited for use in high levels of vibration
- LED indicator as standard
- CE certified
- UL listed



Technical features

Operation:

M/50/EAP (PNP) open collector output with LED (yellow)
M/50/EAN (NPN) grounded emitter output with LED (yellow)
M/50/IOP (PNP) Easy IO-Link open collector output with LED (yellow)

Switching voltage (Ub):

10 ... 30 V d.c.

Switching voltage output:

Ub - 2 V

Inducted voltage:

0,5 V
Switching current (see graph overleaf):
100 mA max.

Switching power:

4,5 W max.

Response time:

< 0,5 ms for EAP switch
< = 1 ms for IOP switch

Operating frequency:

1 kHz

Protection rating (EN 60529):

IP67 (standard)
IP68 for type: M/50/EAP/5U

Operating temperature:

-40 ... +80°C (-40 ... 176°F)
(IP67 & IP68)

Cable type:

PVC 3 x 0,12 (standard)
PUR 3 x 0,14 (M/50/EAP/5U)

Cable length:

2, 5 and 10 m

Electromagnetic compatibility

according to:
EN 60947-5-2

Materials:

Body: plastic
Cable: see table below

Technical data - Solid state

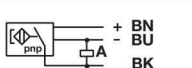
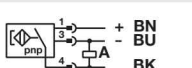
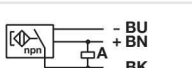
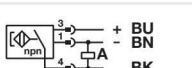
Symbol	Voltage (V d.c.)	Current maximum (mA)	Function	IO-Link *2)	Operating temperature (°C)	LED	Protection class	Plug	Cable length (m)	Cable type	Weight (g)	Model
	10 ... 30	100	PNP		-40 ... +80	•	IP67	—	2, 5 or 10	PVC 3 x 0,12	37	M/50/EAP/*V
	10 ... 30	100	PNP	•	-40 ... +80	•	IP67	—	5	PVC 3 x 0,12	37	M/50/IOP/5V
	10 ... 30	100	PNP		-40 ... +80	•	IP68	—	5	PUR 3 x 0,14	37	M/50/EAP/5U
	10 ... 30	100	PNP		-40 ... +80	•	IP67	M8 x 1	0,3	PVC 3 x 0,14	16	M/50/EAP/CP *1)
	10 ... 30	100	PNP	•	-40 ... +80	•	IP67	M8 x 1	0,3	PVC 3 x 0,14	16	M/50/IOP/CP *1)
	10 ... 30	100	PNP		-40 ... +80	•	IP67	M12 x 1	0,3	PVC 3 x 0,14	16	M/50/EAP/CC *1)
	10 ... 30	100	NPN		-40 ... +80	•	IP67	—	2, 5 or 10	PVC 3 x 0,12	37	M/50/EAN/*V
	10 ... 30	100	NPN		-40 ... +80	•	IP67	M8 x 1	0,3	PVC 3 x 0,14	16	M/50/EAN/CP *1)

* Insert cable length; *1) Plug-in connector see page 12

IO-Link function *2)

- Visual installation aid
- Counter
- Temperature diagnostic
- Power LED

Dimensions

M/50/EAP/*V,
M/50/EAN/*V
M/50/IOP/5V
Cable length L = 2, 5 or 10 m

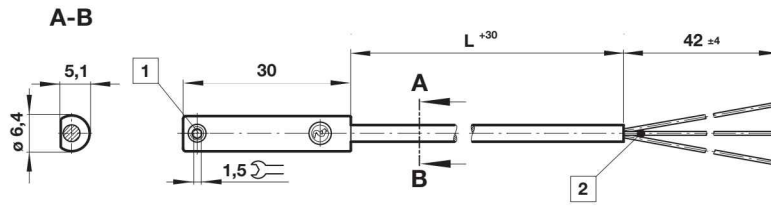

Dimensions in mm
Projection/First angle



M/50/EAP/CP,
M/50/EAN/CP
M/50/IOP/CP

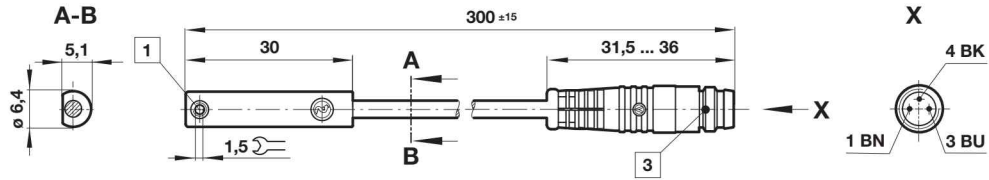

M/50/EAP/CC

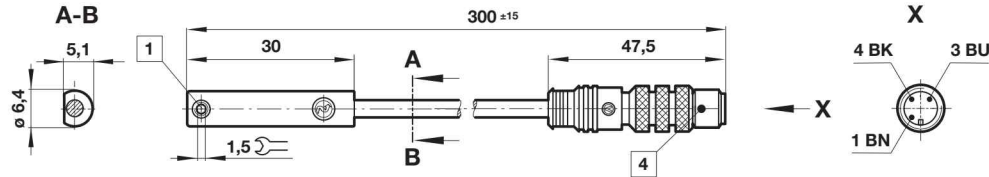

- 1 Fixing screw
- 2 Color code: BK = black; BN = brown; BU = blue
- 3 Plug M8 x 1
- 4 Plug M12 x 1

Accessories

Plug-in connector cable with nut



Outer cover	Cable length (m)	Weight (kg)	Connector	Connector
PVC 3 x 0,25	5	0,18	M8 x 1	M/P73001/5
PUR 3 x 0,25	5	0,18	M8 x 1	M/P73002/5
PUR 3 x 0,34	5	0,21	M12x 1	M/P34594/5

Warning

These products are intended for use in industrial compressed air systems only. Do not use these products where pressures and temperatures can exceed those listed under »**Technical features/ data**«.

Before using these products with fluids other than those specified, for non-industrial applications, life-support systems or other applications not within published specifications, consult Norgren Ltd.

Through misuse, age, or malfunction, components used in fluid power systems can fail in various modes.

The system designer is warned to consider the failure modes of all component parts used in fluid power systems and to provide adequate safeguards to prevent personal injury or damage to equipment in the event of such failure.

System designers must provide a warning to end users in the system instructional manual if protection against a failure mode cannot be adequately provided.

System designers and end users are cautioned to review specific warnings found in instruction sheets packed and shipped with these products.