

## M/58300 Flat suction cups

- Ø 6 ... 150 mm
- Flat cups ideal where minimal movement is required for pliable materials
- Flexible connector for a vertical offset motion
- Level compensator allows variations in product positioning



### Technical features

Medium:  
Vacuum

Cup diameters:  
6, 8, 10, 15, 20, 25, 30, 40, 50, 80, 120, 150 mm

#### Material characteristics

	NBR	VMQ
Resistance	good	fair
Wear	good	fair
Oil	excellent	fair
Weather	good	excellent
Ozone	fair	excellent

Operating temperature:  
NBR cups  
-10 ... +70°C (+14 ... 158°F)  
VMQ cups  
-30 ... +200°C (-22 ... 392°F)

Materials:  
M/58300/01  
Cups: NBR  
Connection fittings: Aluminium  
M/58300/02  
Cups: VMQ  
Connection fittings: Aluminium  
M/58001 .. 02 (Flexible connector)  
Connector: Nickel plated steel  
'O' ring: NBR  
M/58007 .. 09 (Level compensator)  
Bolt: Chromium plated steel  
Moving thread: Brass  
Spring: Steel

### Technical data, suction cups

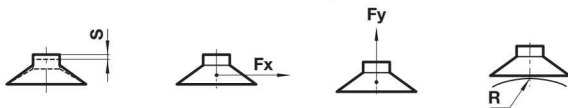

$$F_x = \mu \times F_y$$

Where  $\mu$  is the frictional coefficient of the material being handled.

An approximate guide:

Plastic:  $\mu = 0,4 \dots 0,5$ , Steel, oiled:  $\mu = 0,1 \dots 0,3$ , Glass:  $\mu = 0,3 \dots 0,5$

Symbol	Suction cup Ø (mm)	Port size	Fy -0,2 bar (N)	Fy -0,6 bar (N)	Fy -0,9 bar (N)	Minimum radius of work surface 'R' (mm)	Maximum movement 'S' (mm)	Volume inside (cm³)	Weight (kg)	Model *
	6	M5	0,5	1,5	2,3	5	1,5	0,017	0,001	M/58301/*
	8	M5	1	2,5	3,5	7	1,5	0,041	0,001	M/58302/*
	10	M5	1,5	4	6	9	2	0,065	0,001	M/58303/*
	15	M5	2,7	8	12	12	4	0,33	0,001	M/58304/*
	40	G1/8	19	57,5	86	37	3,5	3	0,011	M/58308/*
	50	G1/8	30	91	135	41	4	4,2	0,016	M/58309/*
	80	G1/8	86	260	390	100	6	21	0,058	M/58310/*
	120	G1/2	180	540	810	365	6	82	0,359	M/58311/*
	150	G1/2	280	842	1250	380	9	177	0,590	M/58312/*

\* Insert material code. NBR: 01, VMQ: 02

Note: Theoretical values are given in this table. Always allow a safety factor of > 2.

### Technical data, flexible connectors and level compensators

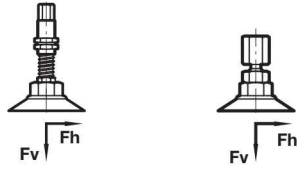

	Port size	Theoretical forces		Return force of spring outstroke F 1 (N)	Return force of spring instroke F 2 (N)	Strokes max. (mm)	Weight (kg)	Model
		Fh max. (N)	Fv max. (N)					
Flexible connector	G1/8, G1/8A	—	300	—	—	—	0,026	M/58001
	G1/2, G1/2A	—	2600	—	—	—	0,115	M/58002
Level compensator	M5	70	200	3,3	5,6	5	0,016	M/58007
	G1/8, G1/8A	250	450	3,5	6,9	15	0,07	M/58008
	G3/8, G1/2A	1000	2600	19,9	40,7	25	0,242	M/58009

### Drawings - Suction cups

Dimensions in mm  
Projection/First angle

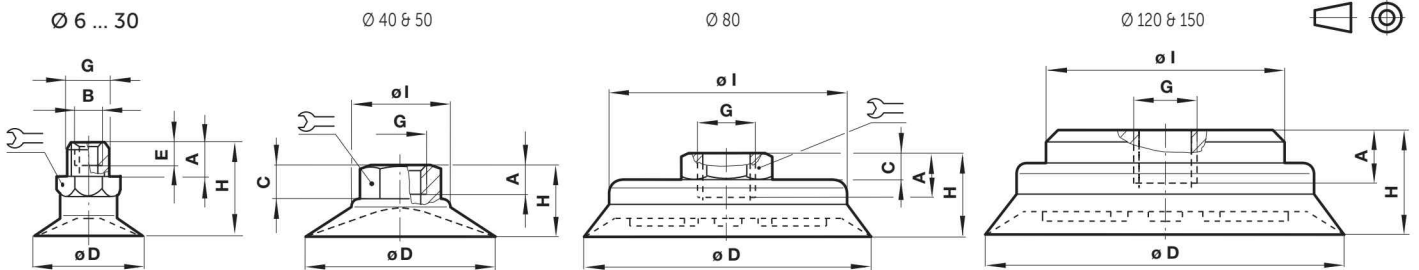

Ø D	A	C	G	H	Ø l		Model
6	4,5	—	M 5	15	—	8	M/58301/*
8	4,5	—	M 5	16	—	8	M/58302/*
10	4,5	—	M 5	20	—	8	M/58303/*
15	4,5	—	M 5	21	—	8	M/58304/*
40	6	9	G 1/8	23	24	14	M/58308/*
50	6	11	G 1/8	26	26	14	M/58309/*
80	13	3,5	G 1/8	21,5	53	19	M/58310/*
120	9,5	—	G 1/2	34,5	65	—	M/58311/*
150	9,5	—	G 1/2	41,5	65	—	M/58312/*

\* Insert material code. nitrile: 01, silicone: 02

## Flexible Connectors



M/58001

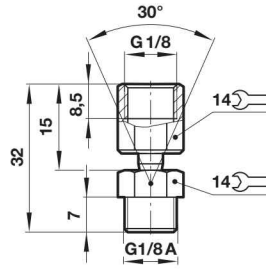

M/58002

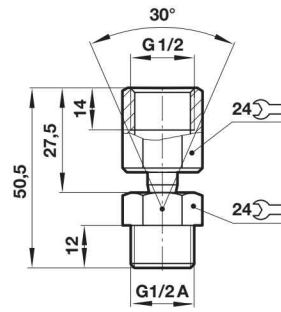

## Level compensators



M/58007

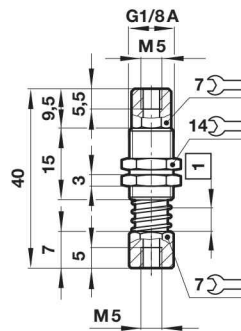

1 5 mm stroke max.

M/58008

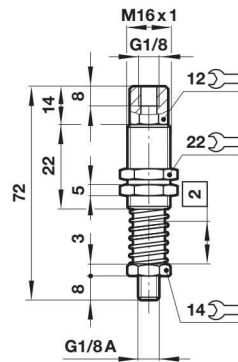

2 15 mm stroke max.

M/58009

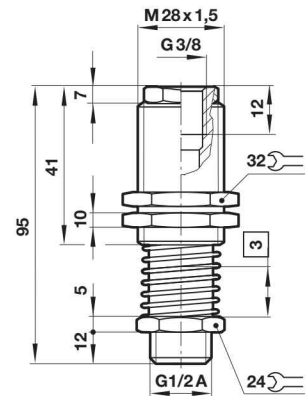

3 25 mm stroke max.

## Warning

These products are intended for use in industrial compressed air systems only. Do not use these products where pressures and temperatures can exceed those listed under

### »Technical features/data«.

Before using these products with fluids other than those specified, for non-industrial applications, life-support systems or other applications not within published specifications, consult IMI Precision Engineering, Norgren GmbH.

Through misuse, age, or malfunction, components used in fluid power systems can fail in various modes.

The system designer is warned to consider the failure modes of all

component parts used in fluid power systems and to provide adequate safeguards to prevent personal injury or damage to equipment in the event of such failure.

System designers must provide a warning to end users in the system instructional manual if protection against a failure mode cannot be adequately provided.

System designers and end users are cautioned to review specific warnings found in instruction sheets packed and shipped with these products.