

SV11-8-4/4M - Solenoid valve

4-way, 2-position spool type solenoid valve
Up to 11 L/min (3 USgpm) • 350 bar (5000 psi)

A

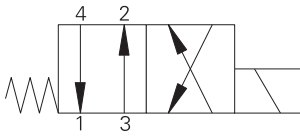

Operation

In the de-energized position this valve allows flow from port 4 to port 1 and from port 3 to port 2.

In the energized position flow is allowed from port 3 to port 4 and from port 2 to port 1

Features

Hardened, ground and honed working parts to limit leakage. IP69K Tough coil compatibility. Continuously rated. Compact design with low Pressure drop. Rated pressure on all ports. Working pressure 350 bar.

Sectional view

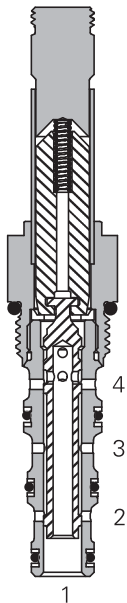

Performance data

Ratings and specifications

Performance data is typical with fluid at 21,8 cSt (105 SUS) and 49°C (120°F)

Typical application pressure (all ports)	350 bar (5000 psi)
Cartridge fatigue pressure (infinite life)	310 bar (4500 psi)
Rated flow	11 L/min (3 USgpm)
Internal leakage (per land)	82 cm ³ /min (5 in ³ /min) max @ 350 bar (5000 psi)
Temperature range	-40° to 100°C (-40° to 212°F)
Coil duty	Continuous from 85% to 110% of nominal voltage
Cavity	C-8-4
Fluids	All general purpose hydraulic fluids such as: MIL-H-5606, SAE 10, SAE 20, etc.
Filtration	Cleanliness code 18/16/13
Housing material (standard)	Steel
Weight including coil	0,14 kg (0.30 lbs)
Seal kit	02-160757 (Buna-N), 02-160758 (Viton®)

Viton is a registered trademark of E.I. DuPont

Description

This is a 4-way 2-position, high pressure, direct acting, spool type solenoid valve. This valve can be used in applications where the motion of a double acting cylinder or a motor needs to be reversed.

Pressure drop

Cartridge only

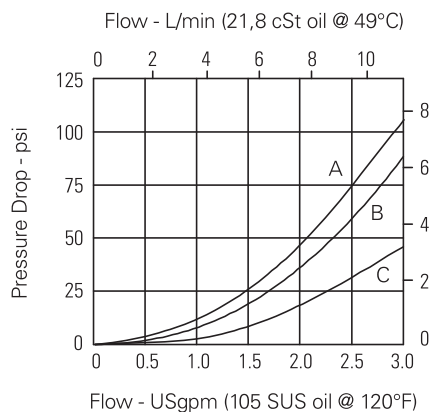

Pressure drop vs. Flow

- A** - Port 3 to port 4 or port 3 to port 2
- B** - Port 4 to 1
- C** - Port 2 to 1

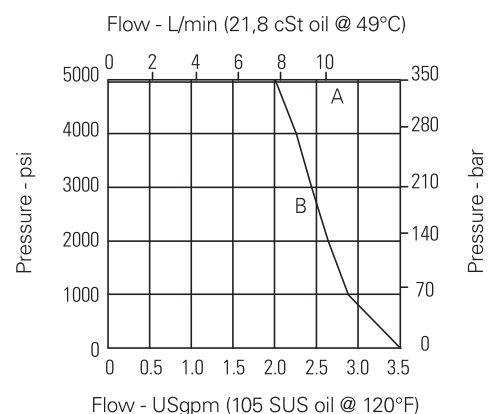

Operating Limits

- A** - Port 2 to port 1, 4 to 1, and 3 to 2
- B** - Port 3 to port 4

Where measurements are critical request certified drawings. We reserve the right to change specifications without notice.

SV11-8-4/4M - Solenoid valve

4-way, 2-position spool type solenoid valve
Up to 11 L/min (3 USgpm) • 350 bar (5000 psi)

Model code

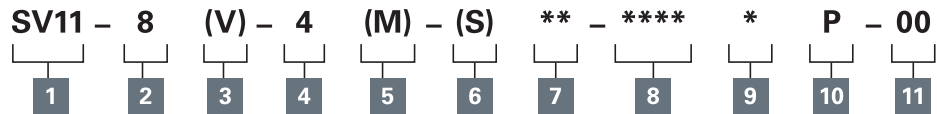

A

1 Function
SV11 - Solenoid valve

2 Size
8 - 8 size

3 Seal material
Blank - Buna-N
V - Viton®

4 Style
4 - 4-way, 2 position

5 Manual override option
Blank - No manual override
M - Manual override
For valve dimensions with Manual override option installed, see page A-980.

6 Valve housing material
Blank - Cartridge only
A - Aluminum

Dimensions
mm (inch)

Cartridge only

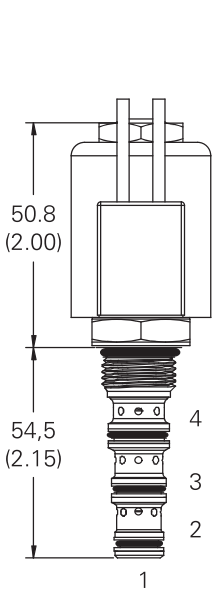

7 Port size

Code	Port size	Housing number
0	Cartridge only	
2G	1/4" BSPP	02-160751
3G	3/8" BSPP	02-160752
4T	SAE 4	02-160753
6T	SAE 6	02-160754

See section J for housing details.

8 Voltage rating

00 - No coil	24A - 24VAC
12D - 12VDC	115A - 115VAC
24D - 24VDC	230A - 230VAC
36D - 36VDC	12B - 12VDC/w diode*
	24B - 24VDC/w diode*

*Optional arc suppression diode.

9 Connector types
Blank - No coil
G - ISO 4400 DIN 43650
Q - Spade terminals
W - Flying lead
N - Deutsch (DC only)
Y - Amp JR (DC only)
D - Metripack 150 male (DC only)
J - Metripack 280 male (DC only)

For coil part numbers and dimensions see section C.

10 Coil series
P - 8 series, 23 W
For coil part numbers and dimensions see section C.

11 Special features
00 - None
(Only required if valve has Special features omitted if "00".)

Torque cartridge in steel or aluminum housing 34-41 Nm (25-30 ft lbs)

Note: When solenoid valve is ordered as Cartridge only, nut is included.

Installation drawing

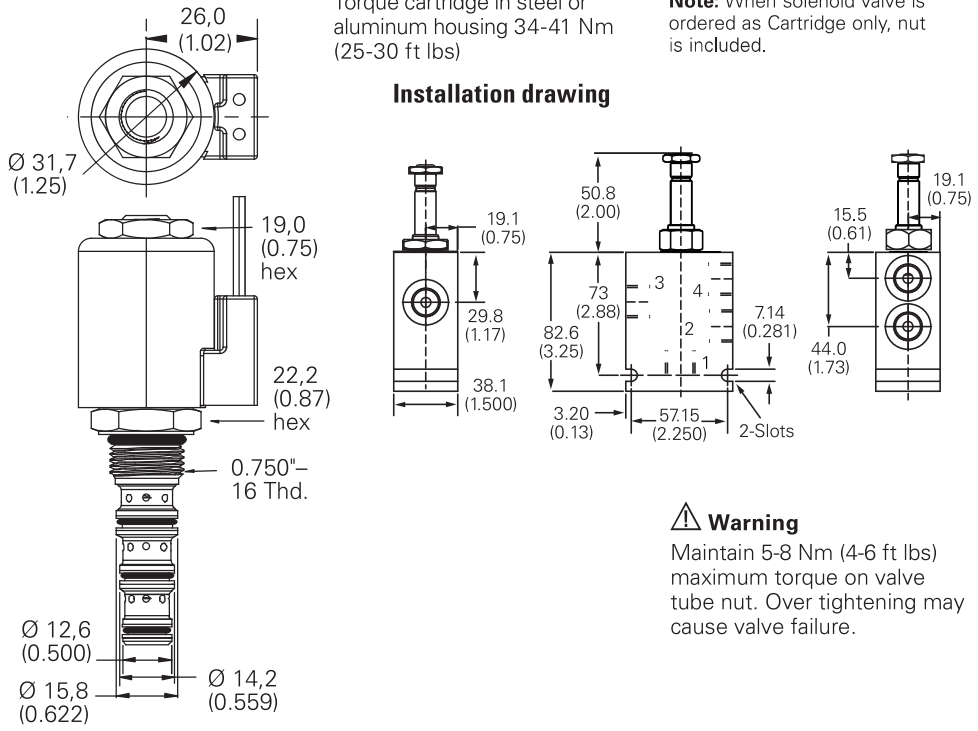

Warning
Maintain 5-8 Nm (4-6 ft lbs) maximum torque on valve tube nut. Over tightening may cause valve failure.

Where measurements are critical request certified drawings. We reserve the right to change specifications without notice.