



MONOBLOCK

TYPE EM103/...38...

6

MONOBLOCCO

TIPO EM103/...38...

Monoblock with side and rear ports A-B = 3/8"G, P-T = 1/2"G
 Parallel connection. With/without pressure relief valve. (RV)
 Monoblocco con utilizzi A-B posteriori e laterali da 3/8"G, P-T da 1/2"G
 Versione in parallelo, con/senza valvola limitatrice di pressione.

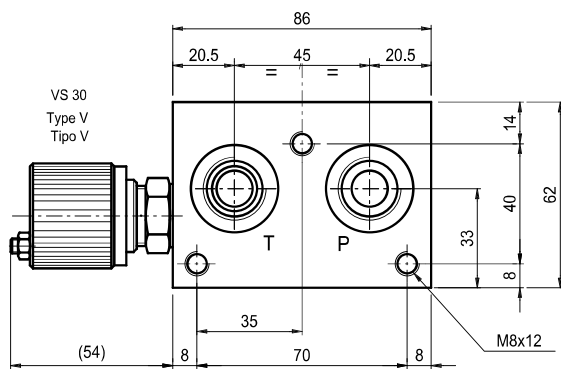

N° Elem.	H	K	(Kg)
1	110	94	3.4
* 2	160	144	4.8
* 3	210	194	6.2
* 4	260	244	7.6
5	310	294	9
6	360	344	10.4
7	410	394	11.8
8	460	444	13.2
9	510	494	14.6
10	560	544	16
11	610	594	17.4

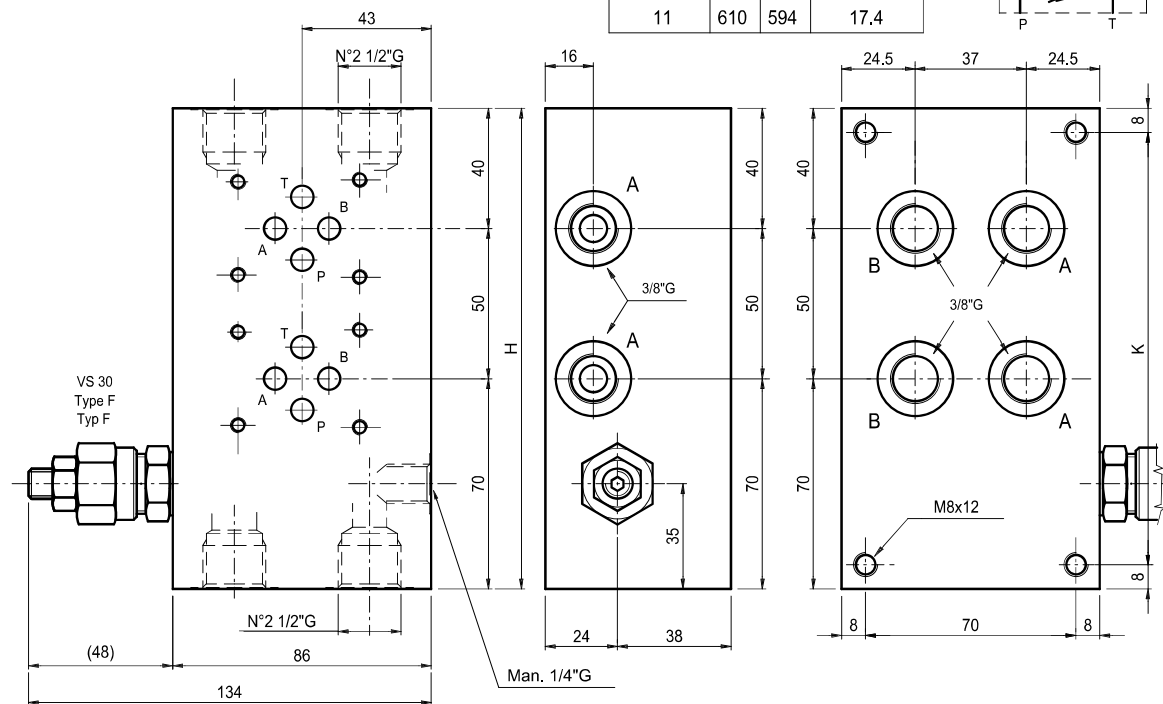
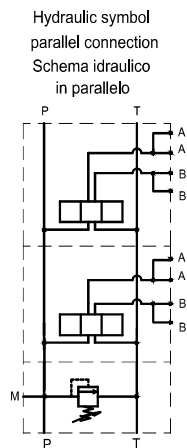

Ordering code:

Esempio di ordinazione: EM 10 3 / * 38 * * *

Setting regolazione

F = by key / a chiave
 V = handwheel/ Volantino
 P = plastic knob/ Pomolo

EUROFLUID monoblock = M
 Monoblocco =
 rear / side ports 10
 versione poster./later.

CETOP 3

N. of elements = 1, 2, ..., 11
 N° stazioni

3/8"G = 38

Spring type / tipo molla

0 = 5-50 bar 2 = 50-210 bar
 1 = 30-100 bar 3 = 100-350 bar

Z = prearranged for RV
 = con sede per VLP
 T = with plugged RV seat
 = con sede tappata per VLP

X = with RV included
 = con VLP inclusa

* Y = without RV seat (only 2-3-4 elements)
 = senza sede VLP (solo 2-3-4 staz.)

NOTES : See page 91 for technical characteristics of RV
 NOTA: Per informazioni tecniche relative alla VLP vedere pag 91