

# ICE30 - Overcenter valve

Pilot assisted relief with check  
30L/min (8 USgpm) • 270 bar (4000 psi)

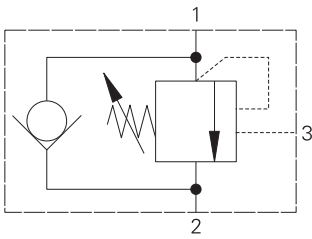

## Sectional View

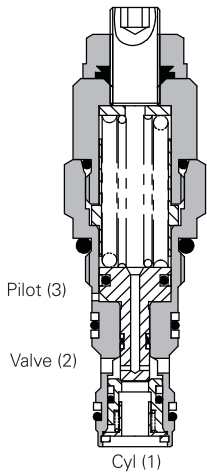

## Description

Overcenter valves give static and dynamic control of loads by regulating the flow into and out of hydraulic actuators. When installed close to or within an actuator, the overcenter valve will stop runaway in the event of hose burst and if open center directional control valves are used, will allow thermal expansion relief of the hydraulic fluid.

The overcenter cartridge is ideal for mounting directly into a cavity machined in the body of the cylinder, motor or rotary actuator. The cartridge can also be mounted directly to the ports via a specifically machined body as part of a Hydraulic Integrated Circuit or single unit, or contained within one of our standard line bodies.

Single overcenter valves are normally used when the load is unidirectional, for example an aerial platform or crane and dual overcenter valves are used for controlling loads in both directional for motor applications or for cylinders going over center.

## Operation

The check section allows free flow into the actuator then holds and locks the load against movement. The pilot assisted relief valve section will give controlled movement when pilot pressure is applied. The relief section is normally set to open at a pressure at least 1.3 times the maximum load induced pressure but the pressure required to open the

valve and allow movement depends on the pilot ratio of the valve. For optimization of load control and energy usage, a choice of pilot ratios is available.

The pressure required to open the valve and start actuator movement can be calculated as follows:

$$\text{Pilot Pressure} = \frac{(\text{Relief Setting}) - (\text{Load Pressure})}{\text{Pilot Ratio}}$$

## Features

Cartridge is economical and fits simple cavity. Allows quick, easy field service - reduces down time. Interchangeable with pilot check valve of a similar size.

## Pilot ratio

2.5:1 Best suited for extremely unstable applications such as long booms or flexible frameworks.

5:1 (standard) Best suited for applications where load varies and machine structure can induce instability.

10:1 Best suited for applications where the load remains relatively constant.

## Performance data

### Ratings and specifications

Figures based on: Oil Temp = 40° C Viscosity = 32 cSt (150 SUS)

Rated flow	30 L/min (8 USgpm)
Max relief pressure	350 bar (5000 psi)
Max load induced pressure	270 bar (4000 psi)
Cartridge material	Working parts hardened and ground steel. External surfaces zinc plated.
Standard housing material	Aluminum (up to 210 bar). Add suffix "377" for steel option.
Mounting position	Unrestricted
Cavity	A6610 (See Section M)
Torque cartridge into cavity	45 Nm (33 lbs ft)
Weight	1CE30 0.15 kg (0.33 lbs) 1CE35 0.41 kg (0.90 lbs) 1CEE34 0.90 kg (1.98 lbs)
Seal kits	SK395 (Nitrile) SK395V (Viton®)
Filtration	Cleanliness code 18/13 (25 micron nominal)
Temperature range	-30°C to +90°C (-22° to +194°F)
Internal leakage	0.3 milliliters/min nominal (5 dpm)
Nominal viscosity range	5 to 500 cSt

Viton is a registered trademark of E.I. DuPont.

## Pressure drop

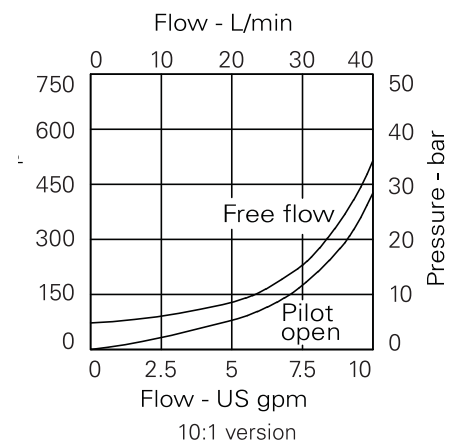
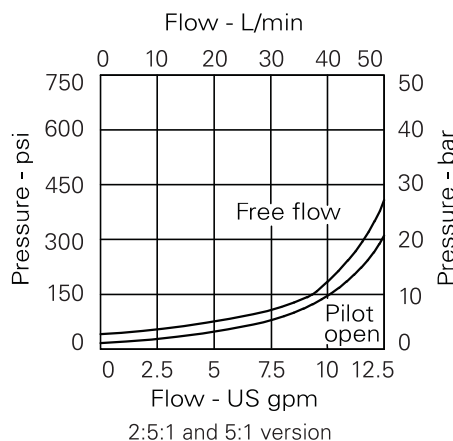

Where measurements are critical request certified drawings. We reserve the right to change specifications without notice.

# ICE30 - Overcenter valve

Pilot assisted relief with check  
30L/min (8 USgpm) • 270 bar (4000 psi)

## Model code

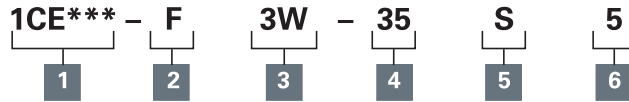

### 1 Function

- 1CE30** - Cartridge Only
- 1CE35** - Cartridge in body
- 1CEE34** - Cartridges in dual body

### 2 Adjustment

- F** - Screw adjustment
  - N** - Fixed
- For fixed versions add setting in 10 bar increments to end of part number. Subject to a +/-10% tolerance.

### 3 Port size

Code	Port size	Housing number - body only			
		Aluminum single	Steel single	Aluminum dual	Steel dual
<b>3W</b>	3/8" BSPP	B6743	B12823	B6836	B13803
<b>6T</b>	3/8" SAE	B10536		B10805	
<b>8T</b>	1/2" SAE	B7884		B30237	

### 4 Pressure range

- Note:** Code based on pressure in bar.
- 20** - (2.5:1 and 5:1): 70-210 bar.  
Std setting 100 bar (10:1): 100-210 bar.  
Std setting 100 bar
  - 35** - (2.5:1 and 5:1): 100-350 bar.  
Std setting 210 bar (10:1): 120-350 bar.  
Std setting 210 bar

### 5 Seal material

- S** - Buna-N
- SV** - Viton

### 6 Pilot ratio

- 2** - 2:1
- 5** - 5:1
- 10** - 10:1

## Dimensions

mm (inch)

### Cartridge only

Basic Code  
1CE30

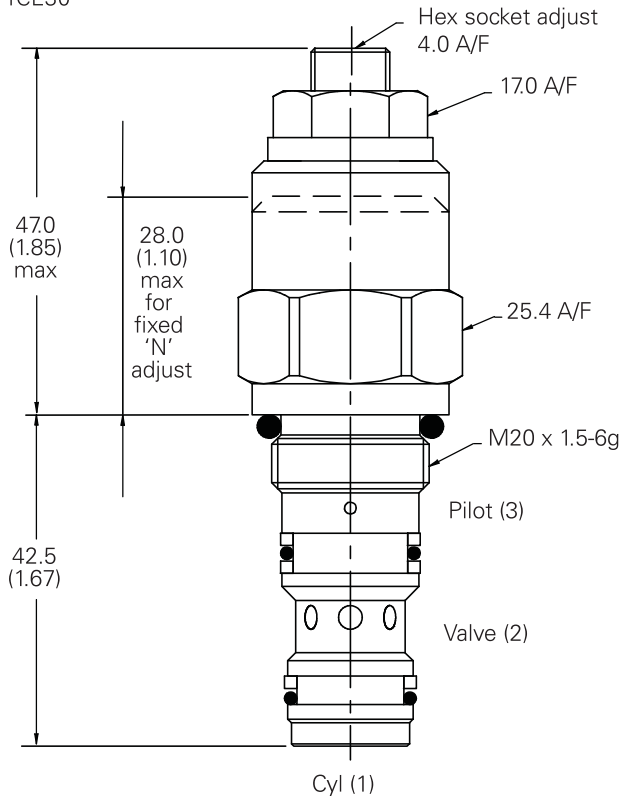

**Note:** For applications above 210 bar - please consult our technical department or use the steel body option

**Note:** Tightening torque of "F" adjuster locknut - 20 to 25 Nm

### Single valve with housing

Basic Code  
1CE35

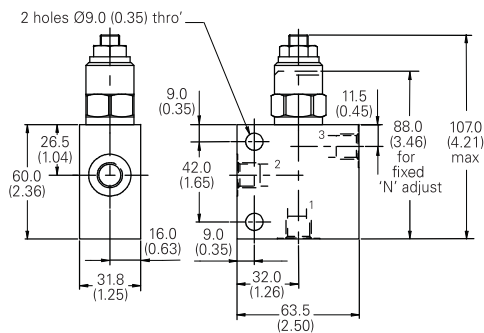

### Double valve with housing

Basic Code  
1CEE34

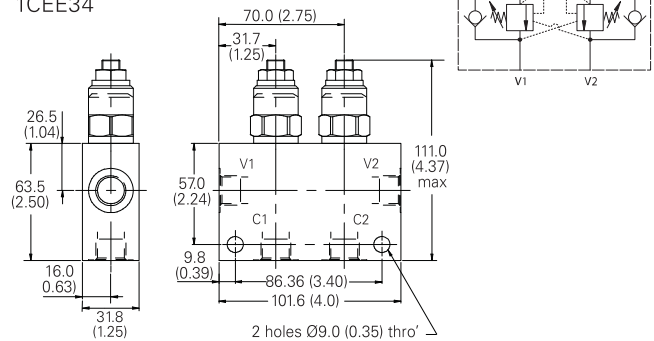

Where measurements are critical request certified drawings. We reserve the right to change specifications without notice.